

652.01.1000

Compressor (Single Cylinder)

Application: 6 BTA A - 5,9/13 150 / 13 170 / 13 180 / 13 190 / 15 170 / 15 180 / 15 190



OEM	OE
9111550500	3357106 2TO100759A

Cylinder Bore	Ø85
Stroke	56
Swept Volume	318
Air Inlet Port Size	3/4-14NPT
Air Delivery Port Size	3/4-14NPT
Number of Cylinders	1
Through Drive	YES
Unloader Port Size	-
Water Or Air Cooled	W
Water Inlet Port Size	1/2-14NPT
Water Delivery Port Size	1/2-14NPT
Water Cooled Valve Plate	YES

Components

663.01.1100 Crankcase

OEM	OE

652.01.1200 Cylinder Head

OEM	OE
	9111558022

652.01.1220 Cylinder Upper Head

OEM	OE
	9111556534 8845025414

652.01.1230 Cylinder Lower Head

OEM	OE
	9111556502 9111558032

143.01.1400 Connecting Rod

OEM	OE	
	9111457372 9111457382 9111537302	3357396 0001312417 0001312517

617.01.1500 Crankshaft

OEM	OE

663.01.1510 Pump Adapter

OEM	OE

602.01.1502 Screw for Crankshaft

OEM	OE

663.01.1600 Bearing Cover

OEM	OE

617.01.1640 Cover Kit

OEM	OE

136.01.1700 Piston With Rings (STD)

OEM	OE	
	9115016242 9115016252 9120006272	1283781 1698686 0001303417 0001305317 81541196040
136.01.1700-Ø85.00 mm 136.01.1710-Ø85.25 mm 136.01.1720-Ø85.50 mm 136.01.1730-Ø85.75 mm 136.01.1740-Ø86.00 mm		

132.01.1800 Piston Ring Kit (STD)

OEM	OE	
	9115019202 9118019202	3094621 0011311111
132.01.1800-Ø85.00 mm 132.01.1810-Ø85.25 mm 132.01.1820-Ø85.50 mm 132.01.1830-Ø85.75 mm 132.01.1840-Ø86.00 mm		

652.01.2300 Repair Kit With Bushing

	OEM	OE
		

652.01.2350 Repair Kit w/o Bushing

	OEM	OE
		

652.01.2330 Repair Kit

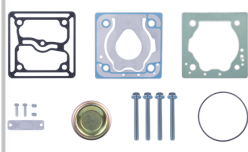
	OEM	OE
		

652.01.1280 Head Repair Kit

	OEM	OE
		

617.01.2100 Gasket & Sealing Kit

	OEM	OE
	9111559212	

652.01.2200 Valve Kit

	OEM	OE
		

617.01.3300 Pump Support

	OEM	OE
		

612.01.2900 Gear

	OEM	OE
		3928861

575.01.2600 Bushing

	OEM	OE
	9111552004	

136.01.1900 Cap

	OEM	OE
	8950735894	1304881 3094835 11712508 0001312321

136.01.2700 Screw Kit

	OEM	OE
	8912119994	

	OEM	OE

	OEM	OE

	OEM	OE

	OEM	OE

	OEM	OE

	OEM	OE

	OEM	OE

652.01.2000

Compressor (Single Cylinder)

Application: 13 150 / 13 170 / 13 180 / 13 190 / 15 170 / 15 180 / 15 190 / 17 210 / 17 220

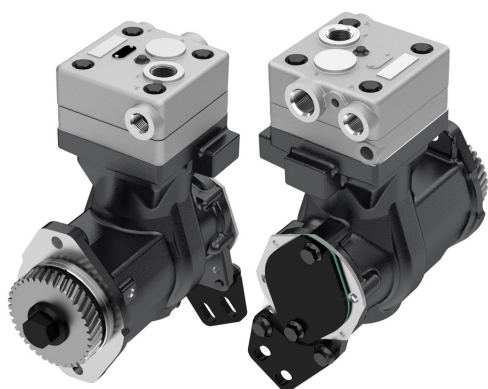

OEM	OE
9111550500	3357106 2TO100759A

Cylinder Bore	Ø85
Stroke	56
Swept Volume	318
Air Inlet Port Size	3/4 14NPT
Air Delivery Port Size	3/4 14NPT
Number of Cylinders	1
Through Drive	YES
Unloader Port Size	-
Water Or Air Cooled	W
Water Inlet Port Size	1/2 14NPT
Water Delivery Port Size	1/2 14NPT
Water Cooled Valve Plate	YES

Components

663.01.1100 Crankcase

OEM	OE

652.01.1200 Cylinder Head

OEM	OE
9111558022	

652.01.1220 Cylinder Upper Head

OEM	OE
9111556534 8845025414	

652.01.1230 Cylinder Lower Head

OEM	OE
9111556502 9111558032	

143.01.1400 Connecting Rod

OEM	OE
9111457372 9111457382 9111537302	3357396 0001312417 0001312517

617.01.1500 Crankshaft

OEM	OE

663.01.1510 Pump Adapter

OEM	OE

602.01.1502 Screw for Crankshaft

OEM	OE

663.01.1600 Bearing Cover

OEM	OE

617.01.1640 Cover Kit

OEM	OE

136.01.1700 Piston With Rings (STD)

OEM	OE
9115016242 9115016252 9120006272	1283781 1698686 0001303417 0001305317 81541196040

136.01.1700-Ø85.00 mm
136.01.1710-Ø85.25 mm
136.01.1720-Ø85.50 mm
136.01.1730-Ø85.75 mm
136.01.1740-Ø86.00 mm

132.01.1800 Piston Ring Kit (STD)

OEM	OE
9115019202 9118019202	3094621 0011311111

132.01.1800-Ø85.00 mm
132.01.1810-Ø85.25 mm
132.01.1820-Ø85.50 mm
132.01.1830-Ø85.75 mm
132.01.1840-Ø86.00 mm

652.01.2300 Repair Kit With Bushing

OEM	OE

652.01.2350 Repair Kit w/o Bushing

OEM	OE

652.01.2330 Repair Kit

OEM	OE

652.01.1280 Head Repair Kit

OEM	OE

617.01.2100 Gasket & Sealing Kit

OEM	OE
9111559212	

652.01.2200 Valve Kit

OEM	OE

575.01.2600 Bushing

OEM	OE
9111552004	

612.01.2900 Gear

OEM	OE
	3928861

617.01.3300 Pump Support

OEM	OE

136.01.2700 Screw Kit

OEM	OE
8912119994	

136.01.1900 Cap

OEM	OE
8950735894	1304881 3094835 11712508 0001312321

OEM	OE

OEM	OE

OEM	OE

OEM	OE

OEM	OE

OEM	OE

OEM	OE

653.01.1000

Compressor (Single Cylinder)

Application: CUMMINS 6 CTA A - 8,3 /VOLKSWAGEN 17 220 / 17 300 / 18 310 TITAN



OEM	OE
9111550600	3357110 2TO100759

Cylinder Bore	Ø85
Stroke	56
Swept Volume	318
Air Inlet Port Size	3/4-14NPT
Air Delivery Port Size	3/4-14NPT
Number of Cylinders	1
Through Drive	YES
Unloader Port Size	-
Water Or Air Cooled	W
Water Inlet Port Size	1/2-14NPT
Water Delivery Port Size	1/2-14NPT
Water Cooled Valve Plate	YES

Components

663.01.1100 Crankcase

OEM	OE

652.01.1200 Cylinder Head

OEM	OE
9111558022	

652.01.1220 Cylinder Upper Head

OEM	OE
9111556534 8845025414	

652.01.1230 Cylinder Lower Head

OEM	OE
9111556502 9111558032	

143.01.1400 Connecting Rod

OEM	OE
9111457372 9111457382 9111537302	3357396 0001312417 0001312517

617.01.1500 Crankshaft

OEM	OE

663.01.1510 Pump Adapter

OEM	OE

602.01.1502 Screw for Crankshaft

OEM	OE

663.01.1600 Bearing Cover

OEM	OE

617.01.1640 Cover Kit

OEM	OE

136.01.1700 Piston With Rings (STD)

OEM	OE
9115016242 9115016252 9120006272	1283781 1698686 0001303417 0001305317 81541196040

136.01.1700-Ø85.00 mm
136.01.1710-Ø85.25 mm
136.01.1720-Ø85.50 mm
136.01.1730-Ø85.75 mm
136.01.1740-Ø86.00 mm

132.01.1800 Piston Ring Kit (STD)

OEM	OE
9115019202 9118019202	3094621 0011311111

132.01.1800-Ø85.00 mm
132.01.1810-Ø85.25 mm
132.01.1820-Ø85.50 mm
132.01.1830-Ø85.75 mm
132.01.1840-Ø86.00 mm

652.01.2300 Repair Kit With Bushing

	OEM	OE
		

652.01.2350 Repair Kit w/o Bushing

	OEM	OE
		

652.01.2330 Repair Kit

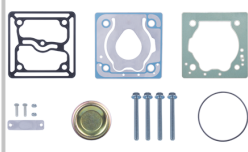
	OEM	OE
		

652.01.1280 Head Repair Kit

	OEM	OE
		

617.01.2100 Gasket & Sealing Kit

	OEM	OE
	9111559212	

652.01.2200 Valve Kit

	OEM	OE
		

617.01.3300 Pump Support

	OEM	OE
		

617.01.2900 Gear

	OEM	OE
		3902595

575.01.2600 Bushing

	OEM	OE
	9111552004	

136.01.1900 Cap

	OEM	OE
	8950735894	1304881 3094835 11712508 0001312321

136.01.2700 Screw Kit

	OEM	OE
	8912119994	

	OEM	OE

	OEM	OE

	OEM	OE

	OEM	OE

	OEM	OE

	OEM	OE

	OEM	OE

653.01.2000

Compressor (Single Cylinder)

Application: VOLKSWAGEN 17 220 / 17 300 / 18 310 TITAN / 24 220 / 24 250 / 40 300

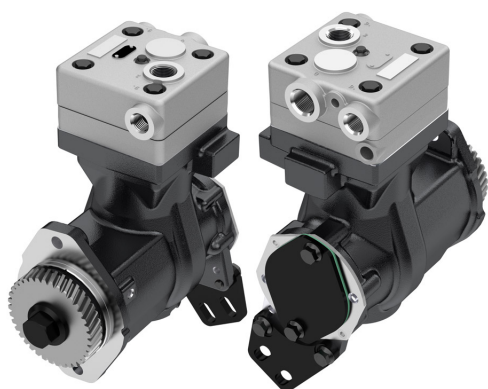

OEM	OE
9111550600	3357110 2TO100759

Cylinder Bore	Ø85
Stroke	56
Swept Volume	318
Air Inlet Port Size	3/4 14NPT
Air Delivery Port Size	3/4 14NPT
Number of Cylinders	1
Through Drive	YES
Unloader Port Size	-
Water Or Air Cooled	W
Water Inlet Port Size	1/2 14NPT
Water Delivery Port Size	1/2 14NPT
Water Cooled Valve Plate	YES

Components

663.01.1100 Crankcase

OEM	OE

652.01.1200 Cylinder Head

OEM	OE
	9111558022

652.01.1220 Cylinder Upper Head

OEM	OE
	9111556534 8845025414

652.01.1230 Cylinder Lower Head

OEM	OE
	9111556502 9111558032

143.01.1400 Connecting Rod

OEM	OE
	9111457372 9111457382 9111537302
	3357396 0001312417 0001312517

617.01.1500 Crankshaft

OEM	OE

663.01.1510 Pump Adapter

OEM	OE

602.01.1502 Screw for Crankshaft

OEM	OE

663.01.1600 Bearing Cover

OEM	OE

617.01.1640 Cover Kit

OEM	OE

136.01.1700 Piston With Rings (STD)

OEM	OE
	9115016242 9115016252 9120006272
	1283781 1698686 0001303417 0001305317 81541196040
136.01.1700-Ø85.00 mm 136.01.1710-Ø85.25 mm 136.01.1720-Ø85.50 mm 136.01.1730-Ø85.75 mm 136.01.1740-Ø86.00 mm	

132.01.1800 Piston Ring Kit (STD)

OEM	OE
	9115019202 9118019202
	3094621 0011311111
132.01.1800-Ø85.00 mm 132.01.1810-Ø85.25 mm 132.01.1820-Ø85.50 mm 132.01.1830-Ø85.75 mm 132.01.1840-Ø86.00 mm	

652.01.2300 Repair Kit With Bushing

		OEM	OE

652.01.2350 Repair Kit w/o Bushing

		OEM	OE

652.01.2330 Repair Kit

		OEM	OE

652.01.1280 Head Repair Kit

		OEM	OE

617.01.2100 Gasket & Sealing Kit

		OEM	OE
		9111559212	

652.01.2200 Valve Kit

		OEM	OE

575.01.2600 Bushing

		OEM	OE
		9111552004	

617.01.2900 Gear

		OEM	OE
			3902595

617.01.3300 Pump Support

		OEM	OE

136.01.2700 Screw Kit

		OEM	OE
		8912119994	

136.01.1900 Cap

		OEM	OE
		8950735894	1304881 3094835 11712508 0001312321

		OEM	OE

		OEM	OE

		OEM	OE

		OEM	OE

		OEM	OE

		OEM	OE

		OEM	OE

654.01.1000

Compressor (Single Cylinder)

Application: CUMMINS 6 CTA A - 8,3 /VOLKSWAGEN 13 170 / 15 170 / 17 210 / 17 220



OEM	OE
9111550610	3357112 2TO100759C

Cylinder Bore	Ø85
Stroke	56
Swept Volume	318
Air Inlet Port Size	3/4-14NPT
Air Delivery Port Size	3/4-14NPT
Number of Cylinders	1
Through Drive	YES
Unloader Port Size	-
Water Or Air Cooled	W
Water Inlet Port Size	1/2-14NPT
Water Delivery Port Size	1/2-14NPT
Water Cooled Valve Plate	YES

Components

654.01.1100 Crankcase

OEM	OE

652.01.1200 Cylinder Head

OEM	OE
	9111558022

652.01.1220 Cylinder Upper Head

OEM	OE
	9111556534 8845025414

652.01.1230 Cylinder Lower Head

OEM	OE
	9111556502 9111558032

143.01.1400 Connecting Rod

OEM	OE	
	9111457372 9111457382 9111537302	3357396 0001312417 0001312517

617.01.1500 Crankshaft

OEM	OE

605.01.1510 Pump Adapter

OEM	OE

602.01.1502 Screw for Crankshaft

OEM	OE

617.01.1600 Bearing Cover

OEM	OE

617.01.1640 Cover Kit

OEM	OE

136.01.1700 Piston With Rings (STD)

OEM	OE	
	9115016242 9115016252 9120006272	1283781 1698686 0001303417 0001305317 81541196040
136.01.1700-Ø85.00 mm 136.01.1710-Ø85.25 mm 136.01.1720-Ø85.50 mm 136.01.1730-Ø85.75 mm 136.01.1740-Ø86.00 mm		

132.01.1800 Piston Ring Kit (STD)

OEM	OE	
	9115019202 9118019202	3094621 0011311111
132.01.1800-Ø85.00 mm 132.01.1810-Ø85.25 mm 132.01.1820-Ø85.50 mm 132.01.1830-Ø85.75 mm 132.01.1840-Ø86.00 mm		

652.01.2300 Repair Kit With Bushing

	OEM	OE
		

652.01.2350 Repair Kit w/o Bushing

	OEM	OE
		

652.01.2330 Repair Kit

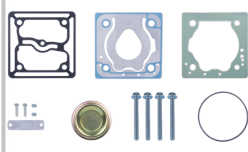
	OEM	OE
		

652.01.1280 Head Repair Kit

	OEM	OE
		

617.01.2100 Gasket & Sealing Kit

	OEM	OE
	9111559212	

652.01.2200 Valve Kit

	OEM	OE
		

617.01.3300 Pump Support

	OEM	OE
		

617.01.2900 Gear

	OEM	OE
		3902595

575.01.2600 Bushing

	OEM	OE
	9111552004	

136.01.1900 Cap

	OEM	OE
	8950735894	1304881 3094835 11712508 0001312321

136.01.2700 Screw Kit

	OEM	OE
	8912119994	

	OEM	OE

	OEM	OE

	OEM	OE

	OEM	OE

	OEM	OE

	OEM	OE

	OEM	OE

654.01.2000

Compressor (Single Cylinder)

Application: VOLKSWAGEN 13 170 / 15 170 / 17 210 / 17 220 / 17 300

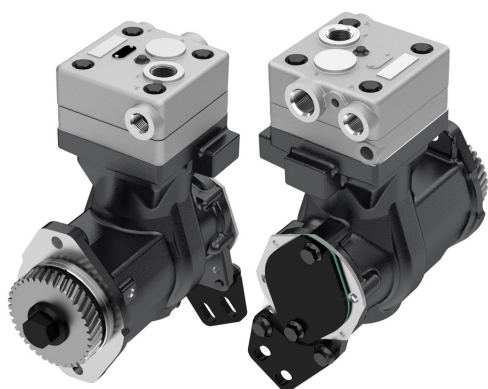

OEM	OE
9111550610	3357112 2TO100759C

Cylinder Bore	Ø85
Stroke	56
Swept Volume	318
Air Inlet Port Size	3/4 14NPT
Air Delivery Port Size	3/4 14NPT
Number of Cylinders	1
Through Drive	YES
Unloader Port Size	-
Water Or Air Cooled	W
Water Inlet Port Size	1/2 14NPT
Water Delivery Port Size	1/2 14NPT
Water Cooled Valve Plate	YES

Components

654.01.1100 Crankcase		OEM	OE

652.01.1200 Cylinder Head		OEM	OE
		9111558022	

652.01.1220 Cylinder Upper Head		OEM	OE
		9111556534 8845025414	

652.01.1230 Cylinder Lower Head		OEM	OE
		9111556502 9111558032	

143.01.1400 Connecting Rod		OEM	OE
		9111457372 9111457382 9111537302	3357396 0001312417 0001312517

617.01.1500 Crankshaft		OEM	OE

605.01.1510 Pump Adapter		OEM	OE

602.01.1502 Screw for Crankshaft		OEM	OE

617.01.1600 Bearing Cover		OEM	OE

617.01.1640 Cover Kit		OEM	OE

136.01.1700 Piston With Rings (STD)		OEM	OE
		9115016242 9115016252 9120006272	1283781 1698686 0001303417 0001305317 81541196040
136.01.1700-Ø85.00 mm 136.01.1710-Ø85.25 mm 136.01.1720-Ø85.50 mm 136.01.1730-Ø85.75 mm 136.01.1740-Ø86.00 mm			

132.01.1800 Piston Ring Kit (STD)		OEM	OE
		9115019202 9118019202	3094621 0011311111
132.01.1800-Ø85.00 mm 132.01.1810-Ø85.25 mm 132.01.1820-Ø85.50 mm 132.01.1830-Ø85.75 mm 132.01.1840-Ø86.00 mm			

652.01.2300 Repair Kit With Bushing

OEM	OE

652.01.2350 Repair Kit w/o Bushing

OEM	OE

652.01.2330 Repair Kit

OEM	OE

652.01.1280 Head Repair Kit

OEM	OE

617.01.2100 Gasket & Sealing Kit

OEM	OE
9111559212	

652.01.2200 Valve Kit

OEM	OE

575.01.2600 Bushing

OEM	OE
9111552004	

617.01.2900 Gear

OEM	OE
	3902595

617.01.3300 Pump Support

OEM	OE

136.01.2700 Screw Kit

OEM	OE
8912119994	

136.01.1900 Cap

OEM	OE
8950735894	1304881 3094835 11712508 0001312321

OEM	OE

OEM	OE

OEM	OE

OEM	OE

OEM	OE

OEM	OE

OEM	OE

663.01.1000

Compressor (Single Cylinder)

Application: 13 150 / 13 170 / 13 180 / 13 190 / 15 170 / 15 180 / 15 190 / 17 210 / 17 2

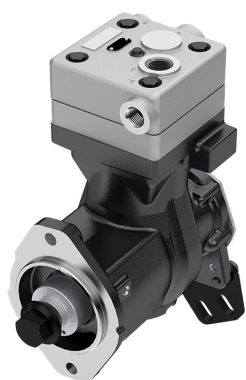

663.01.1000



**663.01.2000
(WITH GEAR)**

OEM	OE
9111550620	4930344 2TO100759D

Cylinder Bore	Ø85
Stroke	56
Swept Volume	318
Air Inlet Port Size	3/4-14NPT
Air Delivery Port Size	3/4-14NPT
Number of Cylinders	1
Through Drive	YES
Unloader Port Size	-
Water Or Air Cooled	W
Water Inlet Port Size	1/2-14NPT
Water Delivery Port Size	1/2-14NPT
Water Cooled Valve Plate	YES

Components

663.01.1100 Crankcase

OEM	OE

652.01.1200 Cylinder Head

OEM	OE
9111558022	

652.01.1220 Cylinder Upper Head

OEM	OE
9111556534 8845025414	

652.01.1230 Cylinder Lower Head

OEM	OE
9111556502 9111558032	

143.01.1400 Connecting Rod

OEM	OE
9111457372 9111457382 9111537302	3357396 0001312417 0001312517

617.01.1500 Crankshaft

OEM	OE

663.01.1510 Pump Adapter

OEM	OE

602.01.1502 Screw for Crankshaft

OEM	OE

663.01.1600 Bearing Cover

OEM	OE

617.01.1640 Cover Kit

OEM	OE

136.01.1700 Piston With Rings (STD)

OEM	OE
9115016242 9115016252 912006272	1283781 1698686 0001303417 0001305317 81541196040

136.01.1700-Ø85.00 mm
136.01.1710-Ø85.25 mm
136.01.1720-Ø85.50 mm
136.01.1730-Ø85.75 mm
136.01.1740-Ø86.00 mm

132.01.1800 Piston Ring Kit (STD)

OEM	OE
9115019202 9118019202	3094621 0011311111

132.01.1800-Ø85.00 mm
132.01.1810-Ø85.25 mm
132.01.1820-Ø85.50 mm
132.01.1830-Ø85.75 mm
132.01.1840-Ø86.00 mm

652.01.2300 Repair Kit With Bushing

	OEM	OE
		

652.01.2350 Repair Kit w/o Bushing

	OEM	OE
		

652.01.2330 Repair Kit

	OEM	OE
		

652.01.1280 Head Repair Kit

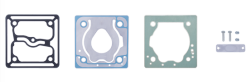
	OEM	OE
		

617.01.2100 Gasket & Sealing Kit

	OEM	OE
	9111559212	

652.01.2200 Valve Kit

	OEM	OE
		

136.01.1900 Cap

	OEM	OE
	8950735894	1304881 3094835 11712508 0001312321

575.01.2600 Bushing

	OEM	OE
	9111552004	

617.01.2900 Gear

	OEM	OE
		3902595

617.01.3300 Pump Support

	OEM	OE
		

136.01.2700 Screw Kit

	OEM	OE
	8912119994	

	OEM	OE

	OEM	OE

	OEM	OE

	OEM	OE

	OEM	OE

	OEM	OE

	OEM	OE

663.01.2000

Compressor (Single Cylinder)

Application: 13 150 / 13 170 / 13 180 / 13 190 / 15 170 / 15 180 / 15 190 / 17 210 / 17 220

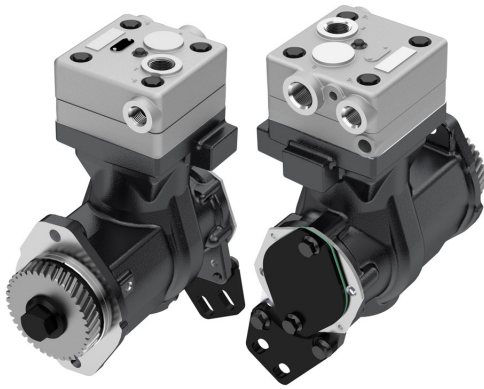

OEM	OE
9111550620	4930344 2TO100759D

Cylinder Bore	Ø85
Stroke	56
Swept Volume	318
Air Inlet Port Size	3/4 14NPT
Air Delivery Port Size	3/4 14NPT
Number of Cylinders	1
Through Drive	YES
Unloader Port Size	-
Water Or Air Cooled	W
Water Inlet Port Size	1/2 14NPT
Water Delivery Port Size	1/2 14NPT
Water Cooled Valve Plate	YES

Components

663.01.1100 Crankcase

OEM	OE

652.01.1200 Cylinder Head

OEM	OE
	9111558022

652.01.1220 Cylinder Upper Head

OEM	OE
	9111556534 8845025414

652.01.1230 Cylinder Lower Head

OEM	OE
	9111556502 9111558032

143.01.1400 Connecting Rod

OEM	OE
	9111457372 3357396 9111457382 0001312417 9111537302 0001312517

617.01.1500 Crankshaft

OEM	OE

663.01.1510 Pump Adapter

OEM	OE

602.01.1502 Screw for Crankshaft

OEM	OE

663.01.1600 Bearing Cover

OEM	OE

617.01.1640 Cover Kit

OEM	OE

136.01.1700 Piston With Rings (STD)

OEM	OE
	9115016242 1283781 9115016252 1698686 912006272 0001303417 0001305317 81541196040
136.01.1700-Ø85.00 mm 136.01.1710-Ø85.25 mm 136.01.1720-Ø85.50 mm 136.01.1730-Ø85.75 mm 136.01.1740-Ø86.00 mm	

132.01.1800 Piston Ring Kit (STD)

OEM	OE
	9115019202 3094621 9118019202 0011311111
132.01.1800-Ø85.00 mm 132.01.1810-Ø85.25 mm 132.01.1820-Ø85.50 mm 132.01.1830-Ø85.75 mm 132.01.1840-Ø86.00 mm	

652.01.2300 Repair Kit With Bushing

OEM	OE

652.01.2350 Repair Kit w/o Bushing

OEM	OE

652.01.2330 Repair Kit

OEM	OE

652.01.1280 Head Repair Kit

OEM	OE

617.01.2100 Gasket & Sealing Kit

OEM	OE
9111559212	

652.01.2200 Valve Kit

OEM	OE

575.01.2600 Bushing

OEM	OE
9111552004	

617.01.2900 Gear

OEM	OE
	3902595

617.01.3300 Pump Support

OEM	OE

136.01.2700 Screw Kit

OEM	OE
8912119994	

136.01.1900 Cap

OEM	OE
8950735894	1304881 3094835 11712508 0001312321

OEM	OE

OEM	OE

OEM	OE

OEM	OE

OEM	OE

OEM	OE

OEM	OE

682.01.1000

Compressor (Single Cylinder)

Application: 24 250 / 19 320E / CONSTELLATION / 26 260E / 31 320E / 19 350E / 25 3

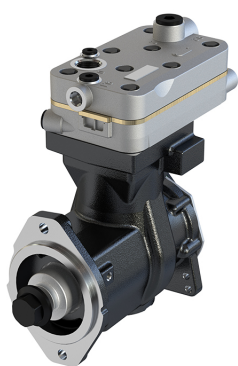

682.01.1000



682.01.2000
(WITH GEAR)

OEM	OE
9111555210	3999917 2T2100759B

Cylinder Bore	Ø85
Stroke	56
Swept Volume	318
Air Inlet Port Size	M30*1,5
Air Delivery Port Size	M26*1,5
Number of Cylinders	1
Through Drive	YES
Unloader Port Size	M12*1,5
Water Or Air Cooled	W
Water Inlet Port Size	M16*1,5
Water Delivery Port Size	M16*1,5
Water Cooled Valve Plate	YES

Components

682.01.1100 Crankcase

OEM	OE

682.01.1200 Cylinder Head

OEM	OE

682.01.1220 Cylinder Upper Head

OEM	OE

283.01.1230 Cylinder Lower Head

OEM	OE

283.01.1300 Coolant Plate

OEM	OE

143.01.1400 Connecting Rod

OEM	OE
	9111457372 9111457382 9111537302
	3357396 0001312417 0001312517

617.01.1500 Crankshaft

OEM	OE

663.01.1510 Pump Adapter

OEM	OE

602.01.1502 Screw for Crankshaft

OEM	OE

663.01.1600 Bearing Cover

OEM	OE

136.01.1700 Piston With Rings (STD)

OEM	OE
	9115016242 9115016252 912006272
	1283781 1698686 0001303417 0001305317 81541196040
136.01.1700-Ø85.00 mm 136.01.1710-Ø85.25 mm 136.01.1720-Ø85.50 mm 136.01.1730-Ø85.75 mm 136.01.1740-Ø86.00 mm	

132.01.1800 Piston Ring Kit (STD)

OEM	OE
	9115019202 9118019202
	3094621 0011311111
132.01.1800-Ø85.00 mm 132.01.1810-Ø85.25 mm 132.01.1820-Ø85.50 mm 132.01.1830-Ø85.75 mm 132.01.1840-Ø86.00 mm	

682.01.2300 Repair Kit With Bushing

OEM	OE

682.01.2350 Repair Kit w/o Bushing

OEM	OE

682.01.2310 Repair Kit With Plate

OEM	OE

682.01.2330 Repair Kit

OEM	OE

283.01.1280 Head Repair Kit

OEM	OE

682.01.2100 Gasket & Sealing Kit

OEM	OE

136.01.2200 Valve Kit

OEM	OE

136.01.2500 Unloader Valve Kit

OEM	OE

617.01.1640 Cover Kit

OEM	OE

603.01.2900 Gear

OEM	OE
	3940239 3942497

575.01.2600 Bushing

OEM	OE
	9111552004

136.01.1900 Cap

OEM	OE
8950735894	1304881 3094835 11712508 0001312321

136.01.2700 Screw Kit

OEM	OE
8912119994	

OEM	OE

OEM	OE

OEM	OE

OEM	OE

OEM	OE

682.01.2000

Compressor (Single Cylinder)

Application: 24 250 / 19 320E / CONSTELLATION / 26 260E / 31 320E / 19 350E / 25 3

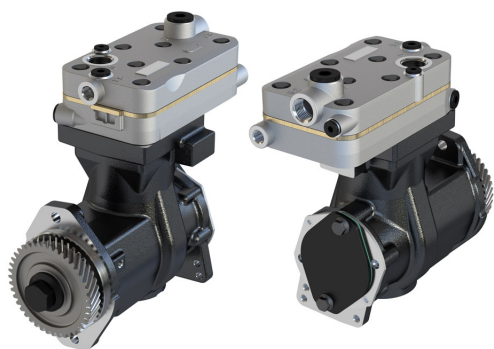

OEM	OE
9111555210	3999917 2T2100759B

Cylinder Bore	Ø85
Stroke	56
Swept Volume	318
Air Inlet Port Size	M30*1,5
Air Delivery Port Size	M26*1,5
Number of Cylinders	1
Through Drive	YES
Unloader Port Size	M12*1,5
Water Or Air Cooled	W
Water Inlet Port Size	M16*1,5
Water Delivery Port Size	M16*1,5
Water Cooled Valve Plate	YES

Components

682.01.1100 Crankcase

OEM	OE

682.01.1200 Cylinder Head

OEM	OE

682.01.1220 Cylinder Upper Head

OEM	OE

283.01.1230 Cylinder Lower Head

OEM	OE

283.01.1300 Coolant Plate

OEM	OE

143.01.1400 Connecting Rod

OEM	OE
	9111457372 9111457382 9111537302
	3357396 0001312417 0001312517

617.01.1500 Crankshaft

OEM	OE

663.01.1510 Pump Adapter

OEM	OE

602.01.1502 Screw for Crankshaft

OEM	OE

663.01.1600 Bearing Cover

OEM	OE

136.01.1700 Piston With Rings (STD)

OEM	OE
	9115016242 9115016252 912006272
	1283781 1698686 0001303417 0001305317 81541196040
136.01.1700-Ø85.00 mm 136.01.1710-Ø85.25 mm 136.01.1720-Ø85.50 mm 136.01.1730-Ø85.75 mm 136.01.1740-Ø86.00 mm	

132.01.1800 Piston Ring Kit (STD)

OEM	OE
	9115019202 9118019202
	3094621 0011311111
132.01.1800-Ø85.00 mm 132.01.1810-Ø85.25 mm 132.01.1820-Ø85.50 mm 132.01.1830-Ø85.75 mm 132.01.1840-Ø86.00 mm	

682.01.2300 Repair Kit With Bushing

OEM	OE

682.01.2350 Repair Kit w/o Bushing

OEM	OE

682.01.2310 Repair Kit With Plate

OEM	OE

682.01.2330 Repair Kit

OEM	OE

283.01.1280 Head Repair Kit

OEM	OE

682.01.2100 Gasket & Sealing Kit

OEM	OE

136.01.2200 Valve Kit

OEM	OE

136.01.2500 Unloader Valve Kit

OEM	OE

575.01.2600 Bushing

OEM	OE
9111552004	

603.01.2900 Gear

OEM	OE
	3940239 3942497

136.01.2700 Screw Kit

OEM	OE
8912119994	

617.01.1640 Cover Kit

OEM	OE

136.01.1900 Cap

OEM	OE
8950735894	1304881 3094835 11712508 0001312321

OEM	OE

OEM	OE

OEM	OE

OEM	OE

OEM	OE

689.01.1000

Compressor (Single Cylinder)

Application: 17.250E CONSTELLATION / 24.250E CONSTELLATION

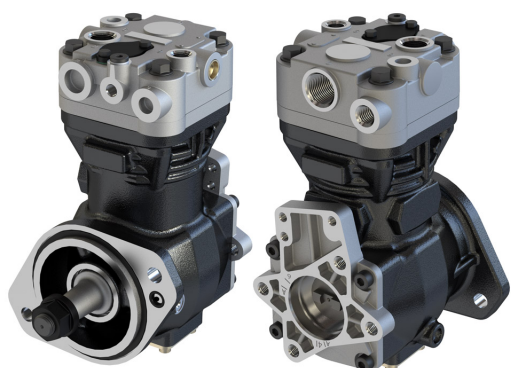

OEM	OE
K01837101	4980796 2R0100759E

Cylinder Bore	Ø80
Stroke	45
Swept Volume	225
Air Inlet Port Size	M26x1.5
Air Delivery Port Size	M22x1.5
Number of Cylinders	1
Through Drive	YES
Unloader Port Size	M10x1
Water Or Air Cooled	W
Water Inlet Port Size	M16x1.5
Water Delivery Port Size	M16x1.5
Water Cooled Valve Plate	YES

Components

689.01.1000 Crankcase

OEM	OE
	

685.01.1200 Cylinder Head

OEM	OE
	K006622

685.01.1210 Cylinder Head With Plate Kit

OEM	OE
	

620.01.1300 Plate Kit

OEM	OE
	SEB01593004 SEB22461
	9P918391

409.01.1400 Connecting Rod

OEM	OE
	SEB22464
	85104324

434.01.1500 Crankshaft

OEM	OE
	

702.01.1600 Bearing Cover

OEM	OE
	

120.01.1900 Bottom Cover Kit

OEM	OE
	

102.01.2600 Bushing

OEM	OE
	EB00819
	1315274 1697278 1697286 5001830853 1697286

434.01.1580 Nut For Crankshaft

OEM	OE
	

120.01.1700 Piston With Rings (STD)

OEM	OE
	SEB22517 SEB01594004
	1452718 1844254 42549206 85104325 7421136656 9P918388
	120.01.1700-Ø80.00 mm 120.01.1710-Ø80.25 mm 120.01.1720-Ø80.50 mm 120.01.1730-Ø80.75 mm 120.01.1740-Ø81.00 mm

120.01.1800 Piston Ring Kit (STD)

OEM	OE
	SEB22463
	120.01.1800-Ø80.00 mm 120.01.1810-Ø80.25 mm 120.01.1820-Ø80.50 mm 120.01.1830-Ø80.75 mm 120.01.1840-Ø81.00 mm

701.01.2300 Repair Kit With Bushing

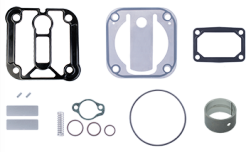
	OEM	OE
		

701.01.2350 Repair Kit w/o Bushing

	OEM	OE
		

701.01.2330 Repair Kit

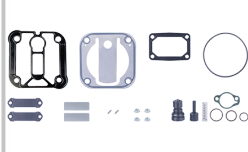
	OEM	OE
	SEB22519	

701.01.2320 Repair Kit

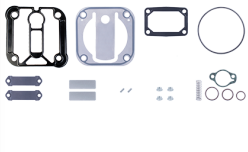
	OEM	OE
		

701.01.2340 Repair Kit

	OEM	OE
		

701.01.1280 Head Repair Kit

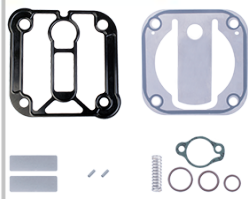
	OEM	OE
		

434.01.2100 Gasket & Sealing Kit

	OEM	OE
		

120.01.2200 Valve Kit

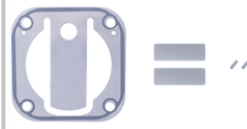
	OEM	OE
		

620.01.2500 Unloader Valve Kit

	OEM	OE
	II38147F0061	5411307715

120.01.2700 Screw Kit

	OEM	OE
		

	OEM	OE

	OEM	OE

	OEM	OE

	OEM	OE

	OEM	OE

	OEM	OE

	OEM	OE

	OEM	OE

704.01.1000

Compressor (Single Cylinder)

Application: 6.90 / 7.90 / 7.100 / 7.110 / 8.100 / 8.130 / 8.140 / 11.130 / 11.140 / 11.160



OEM	OE
II15179	2RH145605
II15178	BF5T2875B
LK38**	

Cylinder Bore	Ø88
Stroke	37
Swept Volume	225
Air Inlet Port Size	1/2'-14 UNF
Air Delivery Port Size	1/2'-14 UNF
Number of Cylinders	1
Through Drive	YES
Unloader Port Size	-
Water Or Air Cooled	W
Water Inlet Port Size	1/2'-14 NPT
Water Delivery Port Size	1/2'-14 NPT
Water Cooled Valve Plate	YES

Components

704.01.2350 Repair Kit w/o Bushing

OEM	OE

704.01.2320 Repair Kit

OEM	OE

704.01.2100 Gasket & Sealing Kit

OEM	OE

130.01.2200 Valve Kit

OEM	OE
II326830061	3091592
II86040061	3091593

130.01.2500 Unloader Valve Kit

OEM	OE
II159920063	3097147

130.01.2800 Cylinder Liner

OEM	OE
K000998	

130.01.2810 Cylinder Liner Kit

OEM	OE
K000998	
II808640061	

130.01.2700 Screw Kit

OEM	OE

110.01.1700 Piston With Rings (STD)

OEM	OE
SEB22555	1361265
II81169004	1409318
	1698848
	3095841
	51541036001
	81541190007
	85101375

110.01.1700-Ø88.00 mm
110.01.1710-Ø88.25 mm
110.01.1720-Ø88.50 mm
110.01.1730-Ø88.75 mm
110.01.1740-Ø89.00 mm

110.01.1800 Piston Ring Kit (STD)

OEM	OE
II811690062	3097153
II39526F0061	85100626

110.01.1800-Ø88.00 mm
110.01.1810-Ø88.25 mm
110.01.1820-Ø88.50 mm
110.01.1830-Ø88.75 mm
110.01.1840-Ø89.00 mm

OEM	OE

OEM	OE

705.01.1000

Compressor (Single Cylinder)

Application: 13.180 / 15.180 / 16.210 CO / 17.210 / 17.210 OD / 17.300 ATÈ 10/2001



OEM	OE
II35214 LK38**	2TJ145605

Cylinder Bore	Ø88
Stroke	37
Swept Volume	225
Air Inlet Port Size	1/214UNF
Air Delivery Port Size	1/214UNF
Number of Cylinders	1
Through Drive	YES
Unloader Port Size	-
Water Or Air Cooled	W
Water Inlet Port Size	1/214NPT
Water Delivery Port Size	1/214NPT
Water Cooled Valve Plate	YES

Components

704.01.1100 Crankcase		OEM	OE

705.01.1200 Cylinder Head		OEM	OE

705.01.1210 Cylinder Head With Plate Kit		OEM	OE

705.01.1300 Plate Kit		OEM	OE

130.01.1400 Connecting Rod		OEM	OE
		I60599 B80110	1698852 0001311817 81541060013

704.01.1500 Crankshaft		OEM	OE

705.01.1650 Front Flange		OEM	OE

130.01.2600 Bushing		OEM	OE
		B44935 B64572	1309548 0001313050 0001313950 81541300009

130.01.2610 Bushing		OEM	OE
		B44935 B64572	0001313150 81541300007

391.01.3300 Pump Support		OEM	OE

110.01.1700 Piston With Rings (STD)		OEM	OE
		SEB22555 I81169004	1361265 1409318 1698848 3095841 51541036001 81541190007 85101375
110.01.1700-Ø88.00 mm 110.01.1710-Ø88.25 mm 110.01.1720-Ø88.50 mm 110.01.1730-Ø88.75 mm 110.01.1740-Ø89.00 mm			

110.01.1800 Piston Ring Kit (STD)		OEM	OE
		I811690062 II39526F0061	3097153 85100626
110.01.1800-Ø88.00 mm 110.01.1810-Ø88.25 mm 110.01.1820-Ø88.50 mm 110.01.1830-Ø88.75 mm 110.01.1840-Ø89.00 mm			

705.01.2350 Repair Kit w/o Bushing

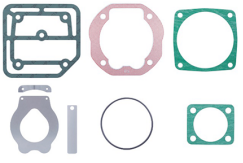
	OEM	OE
		

705.01.2100 Gasket & Sealing Kit

	OEM	OE
		

705.01.2800 Cylinder Liner

	OEM	OE
		

705.01.2810 Cylinder Liner Kit

	OEM	OE
		

	OEM	OE

	OEM	OE

	OEM	OE

	OEM	OE

	OEM	OE

	OEM	OE

	OEM	OE

	OEM	OE

	OEM	OE

	OEM	OE

	OEM	OE

	OEM	OE

	OEM	OE

	OEM	OE

707.01.1000

Compressor (Single Cylinder)

Application: CUMMINS INTERACT 4.0 / 6.0 / 13.170 E / 13.170 E MEX / 15.170 E MEX

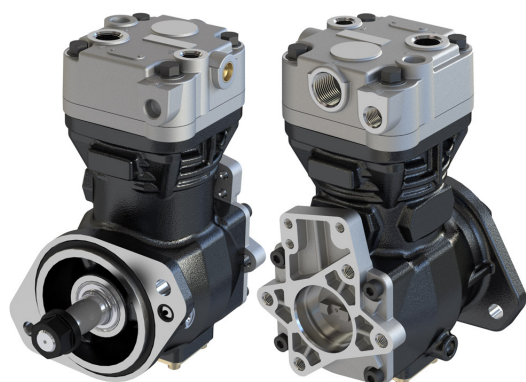

OEM	OE
LK3863	3965888
K001389	2R0100759B
	2T0198389

Cylinder Bore	Ø80
Stroke	45
Swept Volume	225
Air Inlet Port Size	M26x1.5
Air Delivery Port Size	M22x1.5
Number of Cylinders	1
Through Drive	YES
Unloader Port Size	-
Water Or Air Cooled	W
Water Inlet Port Size	M16x1.5
Water Delivery Port Size	M16x1.5
Water Cooled Valve Plate	YES

Components

434.01.1100 Crankcase

OEM	OE

245.01.1200 Cylinder Head

OEM	OE
SEB01629004	1439981
SEB01886	
K009410	

245.01.1210 Cylinder Head With Plate Kit

OEM	OE

120.01.1300 Plate Kit

OEM	OE
SEB01916004	1452714
	1689834
	42549208
	85104326

409.01.1400 Connecting Rod

OEM	OE
SEB22464	85104324

702.01.1500 Crankshaft

OEM	OE

620.01.1580 Nut For Crankshaft

OEM	OE

702.01.1600 Bearing Cover

OEM	OE

120.01.1900 Bottom Cover Kit

OEM	OE

102.01.2600 Bushing

OEM	OE
EB00819	1315274
	1697278
	1697286
	5001830853
	1697286

120.01.1700 Piston With Rings (STD)

OEM	OE
SEB22517	1452718
SEB01594004	1844254
	42549206
	85104325
	7421136656
	9P918388

120.01.1700-Ø80.00 mm
 120.01.1710-Ø80.25 mm
 120.01.1720-Ø80.50 mm
 120.01.1730-Ø80.75 mm
 120.01.1740-Ø81.00 mm

120.01.1800 Piston Ring Kit (STD)

OEM	OE
SEB22463	

120.01.1800-Ø80.00 mm
 120.01.1810-Ø80.25 mm
 120.01.1820-Ø80.50 mm
 120.01.1830-Ø80.75 mm
 120.01.1840-Ø81.00 mm

434.01.2300 Repair Kit With Bushing

OEM	OE

434.01.2350 Repair Kit w/o Bushing

OEM	OE
SEB22461	42549207

434.01.2320 Repair Kit

OEM	OE
SEB22461	

701.01.2340 Repair Kit

OEM	OE

434.01.1280 Head Repair Kit

OEM	OE

434.01.2100 Gasket & Sealing Kit

OEM	OE

120.01.2200 Valve Kit

OEM	OE

120.01.2700 Screw Kit

OEM	OE

120.01.1280 Head Repair Kit

OEM	OE

OEM	OE

OEM	OE

OEM	OE

OEM	OE

OEM	OE

OEM	OE

OEM	OE

OEM	OE

OEM	OE

726.01.1000

Compressor (Single Cylinder)

Application: ISF3.8

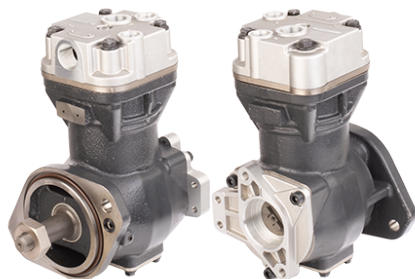

OEM	OE
LK3880	4932265
K019159	4932265

Cylinder Bore	Ø78
Stroke	47
Swept Volume	225
Air Inlet Port Size	M26x1,5
Air Delivery Port Size	M22x1.5
Number of Cylinders	1
Through Drive	Yes
Unloader Port Size	-
Water Or Air Cooled	W
Water Inlet Port Size	M16x1.5
Water Delivery Port Size	M16x1.5
Water Cooled Valve Plate	Yes

Components

726.01.1100 Crankcase

OEM	OE

726.01.1200 Cylinder Head

OEM	OE

726.01.1210 Cylinder Head With Plate Kit

OEM	OE

726.01.1250 Cylinder Head

OEM	OE
 K073295	

726.01.1300 Plate Kit

OEM	OE

726.01.1310 Plate Kit, Complete

OEM	OE
 K073296	

409.01.1400 Connecting Rod

OEM	OE
 SEB22464	85104324

726.01.1500 Crankshaft

OEM	OE

726.01.1600 Bearing Cover

OEM	OE

434.01.1580 Nut For Crankshaft

OEM	OE

552.01.1700 Piston With Rings (STD)

OEM	OE
 SEB22551 SEB22552	5001830855 5001831273 5001867706
552.01.1700-Ø78.00 mm 552.01.1710-Ø78.25 mm 552.01.1720-Ø78.50 mm 552.01.1730-Ø78.75 mm 552.01.1740-Ø79.00 mm	

552.01.1800 Piston Ring Kit (STD)

OEM	OE
552.01.1800-Ø78.00 mm 552.01.1810-Ø78.25 mm 552.01.1820-Ø78.50 mm 552.01.1830-Ø78.75 mm 552.01.1840-Ø79.00 mm	

726.01.2350 Repair Kit w/o Bushing

	OEM	OE
		

726.01.2330 Repair Kit

	OEM	OE
		

726.01.2320 Repair Kit

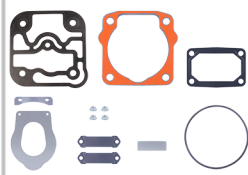
	OEM	OE
		

726.01.2300 Repair Kit

	OEM	OE
		

726.01.2200 Valve Kit

	OEM	OE
		

102.01.2600 Bushing

	OEM	OE
	EB00819	1315274 1697278 1697286 5001830853 1697286

120.01.1900 Bottom Cover Kit

	OEM	OE
		

	OEM	OE

	OEM	OE

	OEM	OE

	OEM	OE

	OEM	OE

	OEM	OE

	OEM	OE

	OEM	OE

	OEM	OE

	OEM	OE

	OEM	OE

803.01.1000

Compressor (Single Cylinder)

Application: VOLKSWAGEN 15.190 / 17.230 / 17.260 / VOLKSWAGEN CONSTELLAT

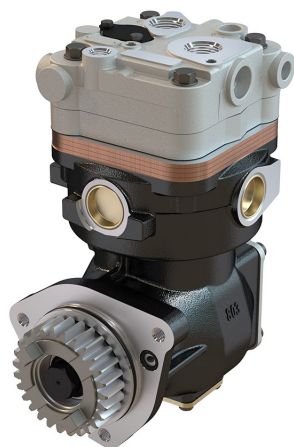

803.01.1000



803.01.2000
(WITH OUT GEAR)

OEM	OE
LK3887	61541007200
K051749	07W820803C
K172999	
K05174960	
K05174961	

Cylinder Bore	Ø92
Stroke	34
Swept Volume	226
Air Inlet Port Size	M26x1,5
Air Delivery Port Size	M26x1,5
Number of Cylinders	1
Through Drive	Yes
Unloader Port Size	M10x1
Water Or Air Cooled	W
Water Inlet Port Size	M16x1,5
Water Delivery Port Size	M16x1,5
Water Cooled Valve Plate	Yes

Components

803.01.1100 Crankcase	OEM	OE

803.01.1200 Cylinder Head	OEM	OE

803.01.1220 Cylinder Upper Head	OEM	OE
	K072142	

516.01.1230 Cylinder Lower Head	OEM	OE
K077669		

803.01.1210 Cylinder Head with Plate Kit	OEM	OE

803.01.1300 Plate Kit	OEM	OE

803.01.1400 Connecting Rod	OEM	OE

803.01.1500 Crankshaft	OEM	OE

803.01.1502 Screw for crankshaft	OEM	OE

270.01.1600 Bearing Cover	OEM	OE

122.01.1700 Piston With Rings (STD)	OEM	OE
	SEB22530 K006026 K012079	21136690 7421136690 51541196008 51541196009
122.01.1700-Ø92.00 mm 122.01.1710-Ø92.25 mm 122.01.1720-Ø92.50 mm 122.01.1730-Ø92.75 mm 122.01.1740-Ø93.00 mm		

122.01.1800 Piston Ring Kit (STD)	OEM	OE
122.01.1800-Ø92.00 mm 122.01.1810-Ø92.25 mm 122.01.1820-Ø92.50 mm 122.01.1830-Ø92.75 mm 122.01.1840-Ø93.00 mm		

803.01.2300 Repair Kit With Bushing		
	OEM	OE
		

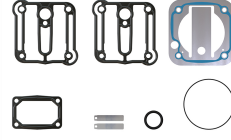
803.01.2350 Repair Kit w/o Bushing		
	OEM	OE
		

803.01.2320 Repair Kit		
	OEM	OE
		

803.01.2330 Repair Kit		
	OEM	OE
		

803.01.1280 Head Repair Kit		
	OEM	OE
		

803.01.2100 Gasket & Sealing Kit		
	OEM	OE
		

307.01.2200 Valve Kit		
	OEM	OE
		

670.01.2500 Unloader Valve Kit		
	OEM	OE
 K034874K50		

120.01.1900 Bottom Cover Kit		
	OEM	OE
		

102.01.2600 Bushing		
	OEM	OE
	EB00819	1315274 1697278 1697286 5001830853 1697286

481.01.2600 Bushing		
	OEM	OE
		

130.01.2700 Screw Kit		
	OEM	OE
		

286.01.2900 Gear		
	OEM	OE
		51542100164 51542100205

	OEM	OE

	OEM	OE

	OEM	OE

	OEM	OE

	OEM	OE